

SEPTIC TANK - 6,500 GALLON (H-20)

ST-6500-H-20

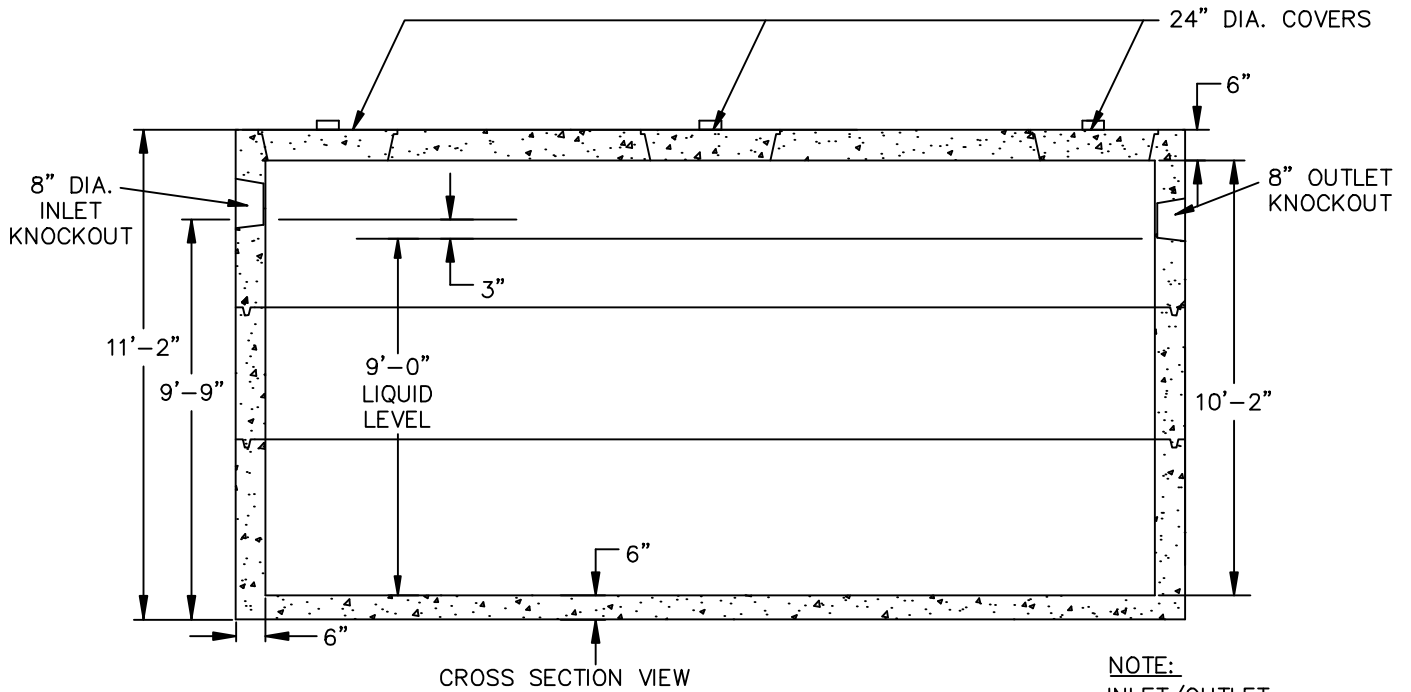
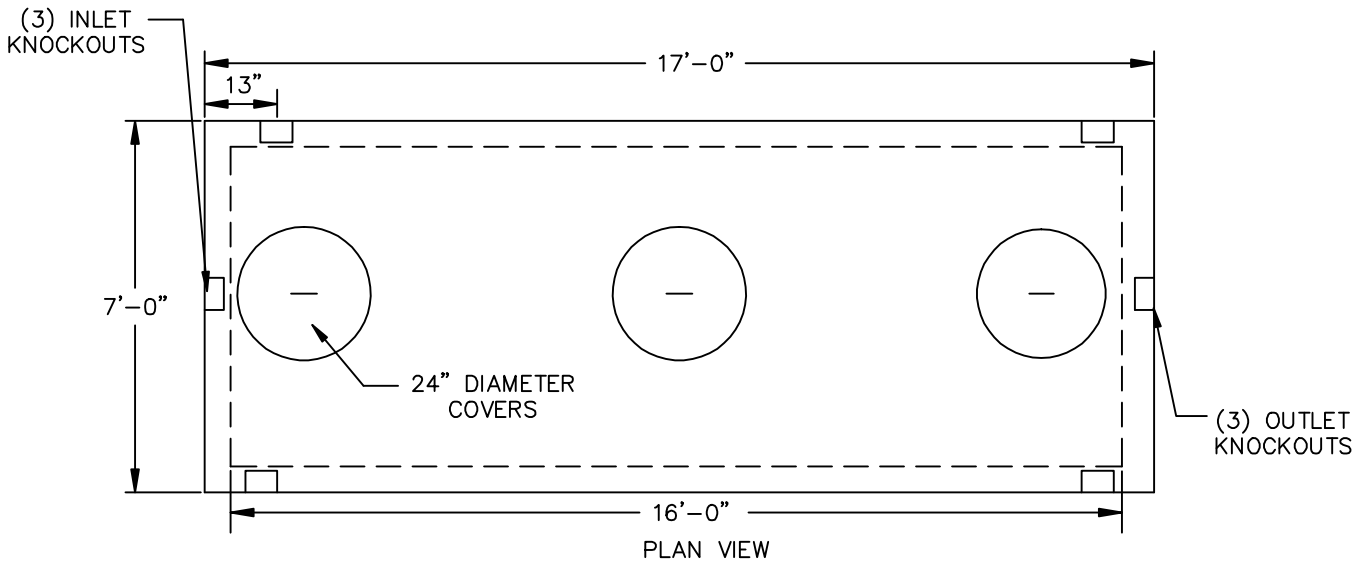

NOTE:
INLET/OUTLET
PVC TEES BY
CUSTOMER

SPECIFICATIONS

- Concrete Minimum Strength: 5,000 P.S.I @ 28 days
- Steel Reinforcement: AS-615-68, Grade 60
- Design Loading: AASHTO - H-20 Meets ASTM Spec. C1227
- Weight: 51,840 lbs.