

**SHOREY
PRECAST
CONCRETE
PRODUCTS**

**SEPTIC TANK
4,000 GALLON (H-20)
ST-4000-H-20**

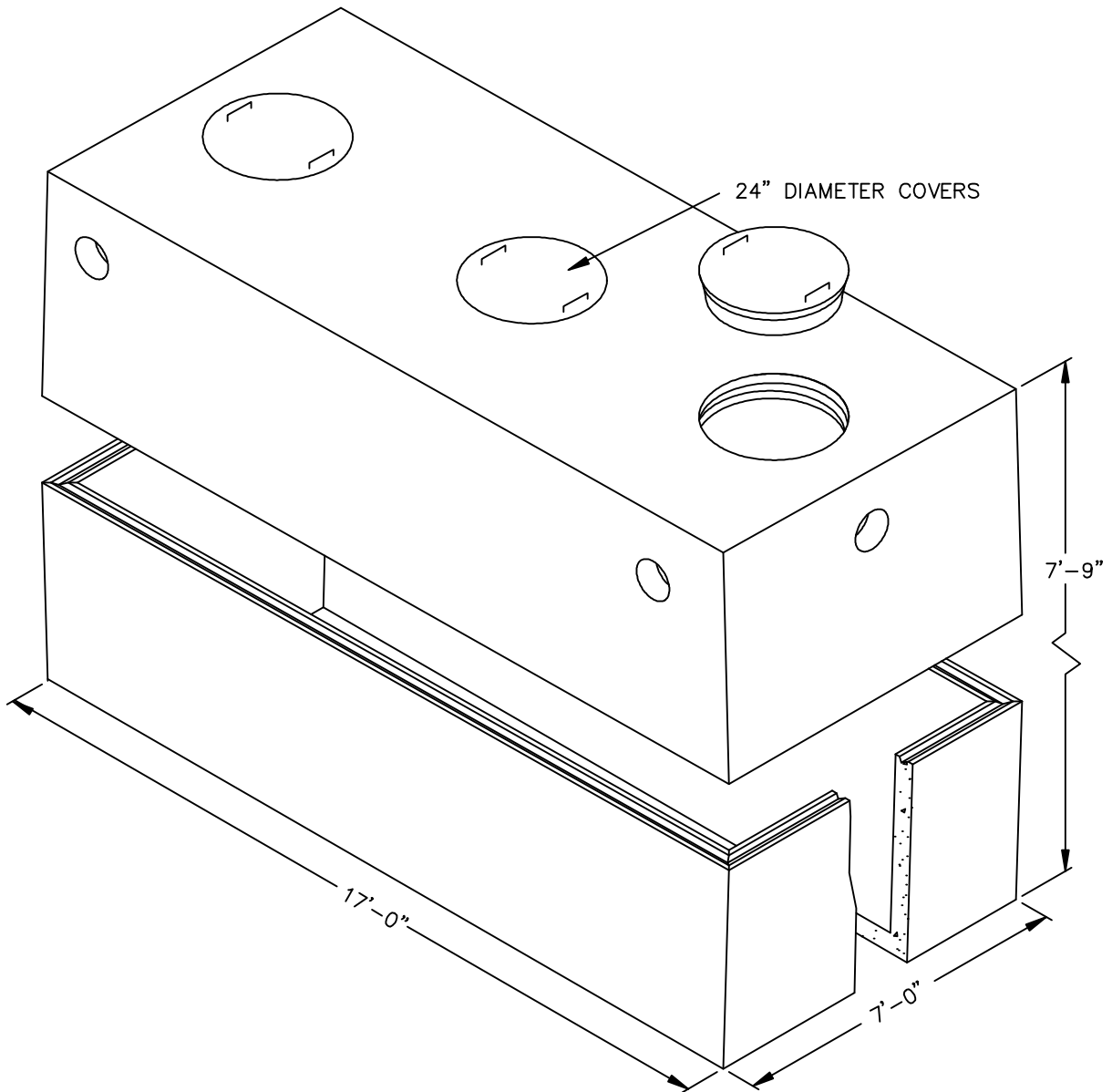

SHOREY PRECAST CONCRETE PRODUCTS

351 Whites Path

S. Yarmouth, MA 02664

(800) 439-0965 • (508) 760-1070