

SEPTIC TANK - 2,500 GALLON (H-20)

ST-2500-H-20

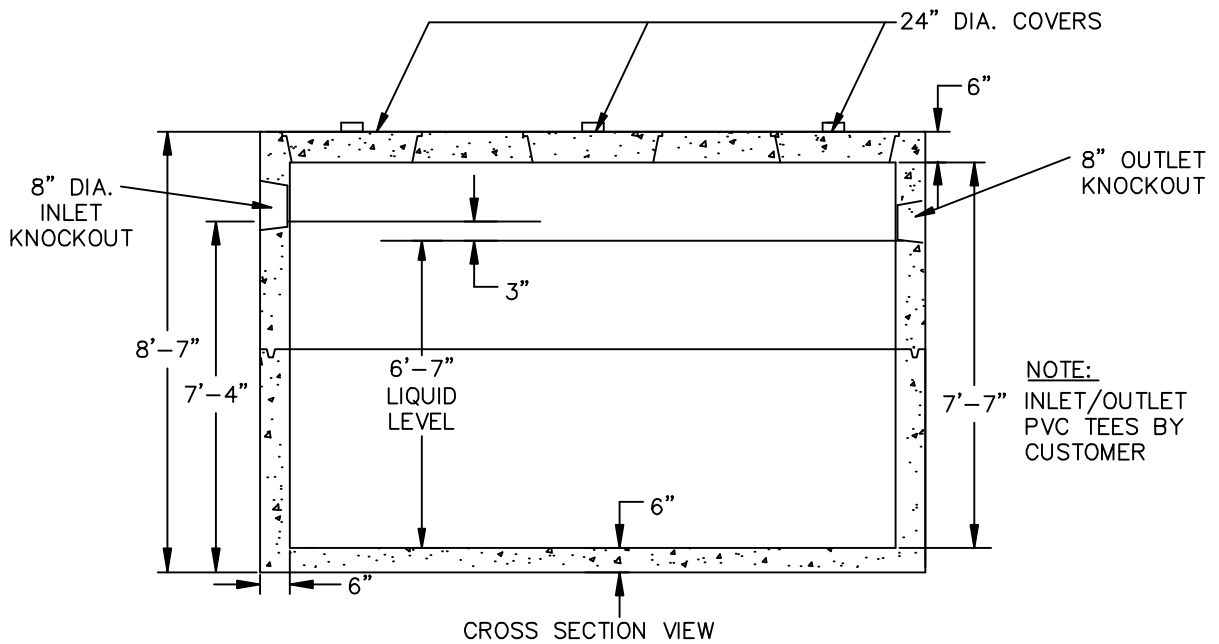
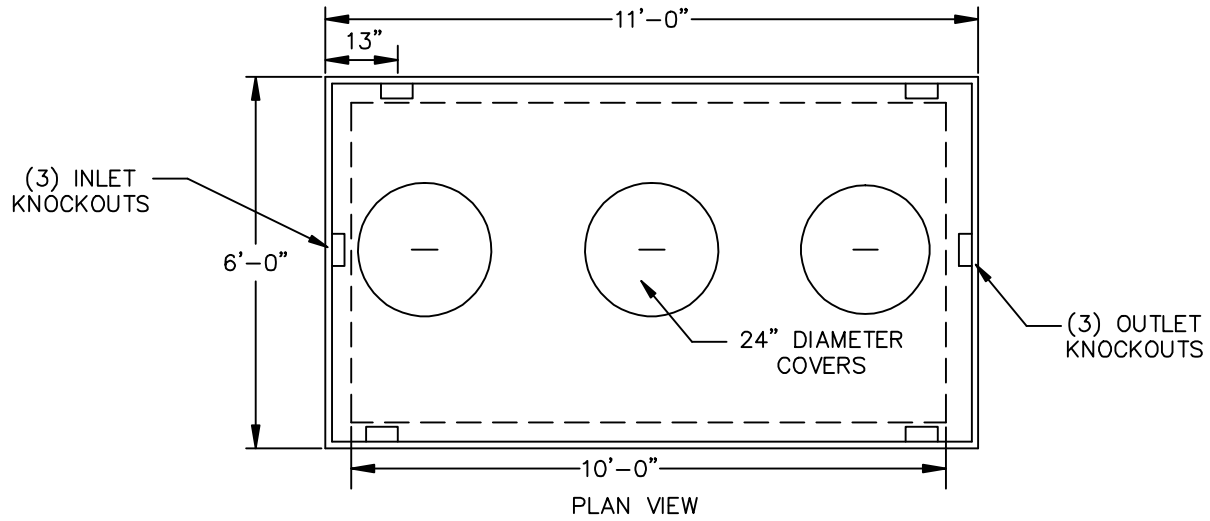

SPECIFICATIONS

- Concrete Minimum Strength: 4,000 P.S.I @ 28 days
- Steel Reinforcement: AS-615-68, Grade 60
- Design Loading: AASHTO - H-20 Meets ASTM Spec. C1227
- Weight: 28,000 lbs.