

SHOREY PRECAST CONCRETE PRODUCTS

12" DIA. LIGHT POLE BASE

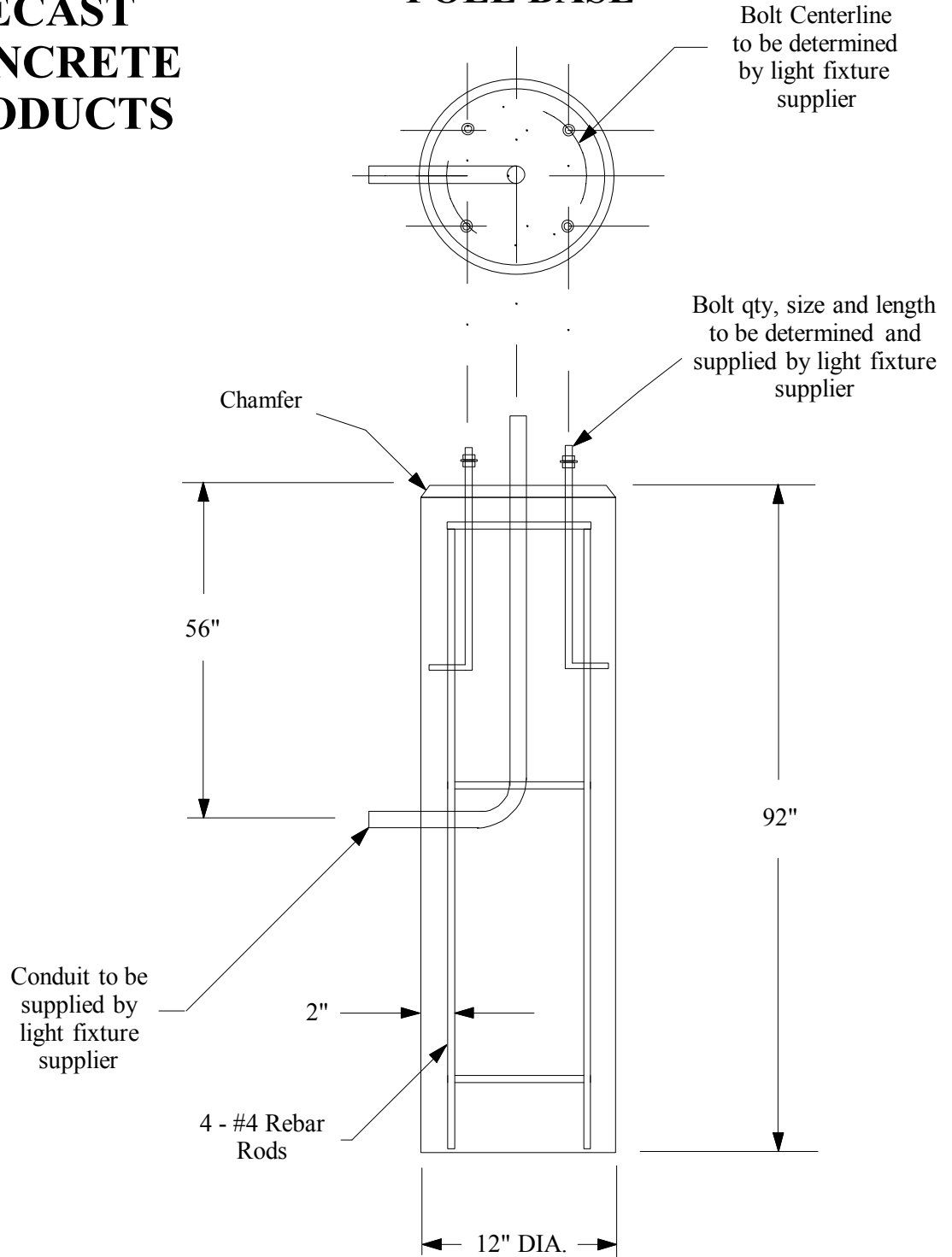

- Concrete Minimum Strength: 5,000 P.S.I @ 28 days
- Steel Reinforcement: AS-615-68, Grade 60
- Design Loading: AASHTO - H-20
- Meets ASTM Spec. C1227
- Weight: 880 lbs.

SHOREY PRECAST CONCRETE PRODUCTS

351 Whites Path

S. Yarmouth, MA 02664

(800) 439-0965 • (508) 760-1070