

# LOW PROFILE SEPTIC TANK 6,000 GAL. (H-20) ST-LOW-6000-H-20

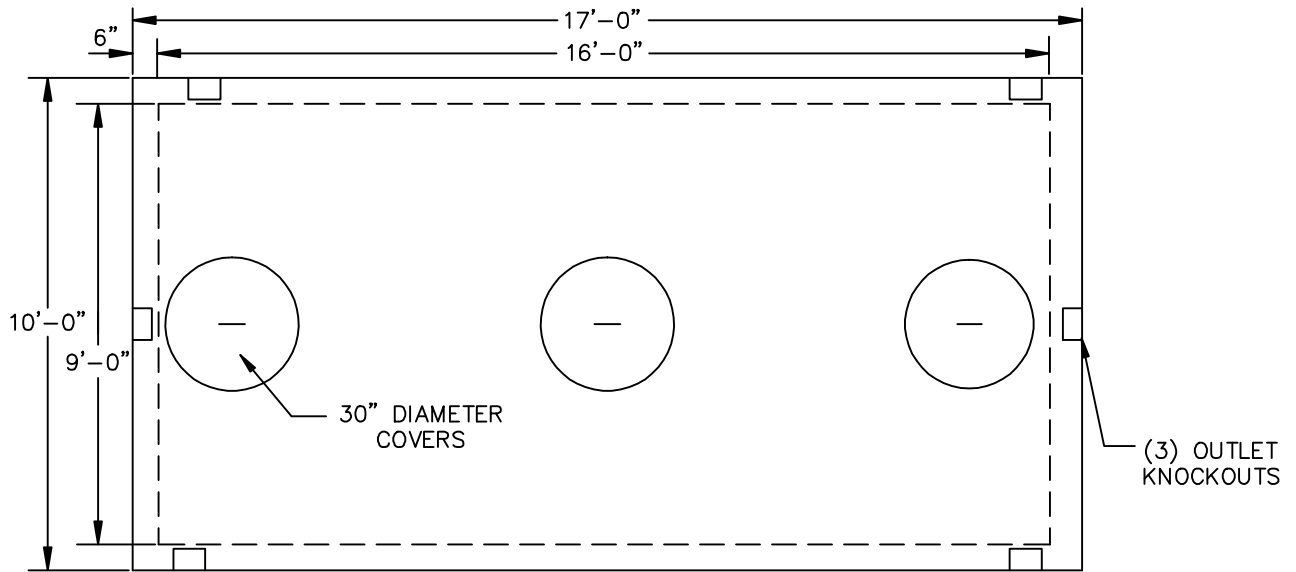

PLAN VIEW

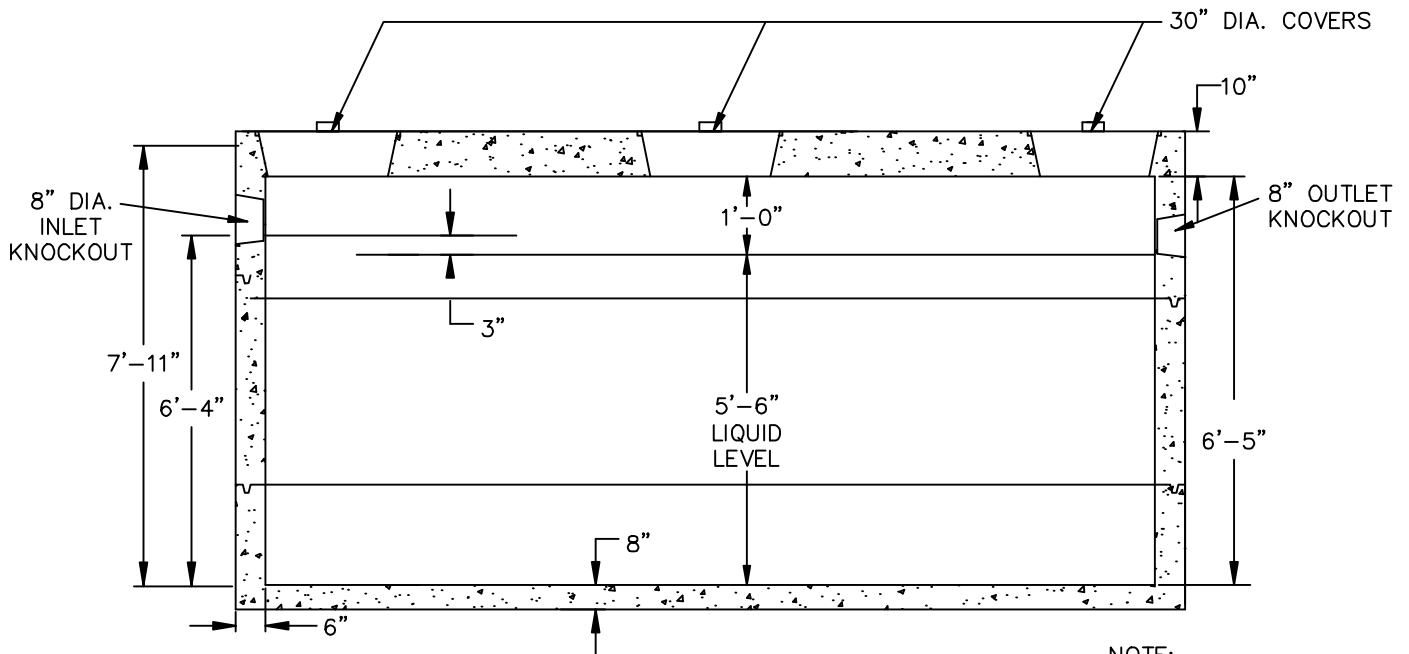

CROSS SECTION VIEW

NOTE:  
INLET/OUTLET  
PVC TEES BY  
CUSTOMER

## SPECIFICATIONS

- Concrete Minimum Strength: 5,000 P.S.I @ 28 days
- Steel Reinforcement: AS-615-68, Grade 60
- Design Loading: AASHTO - H-20 Meets ASTM Spec. C1227
- Weight: 62,840 lbs.