

**SHOREY  
PRECAST  
CONCRETE  
PRODUCTS**

**30" Diameter  
H20 Risers**

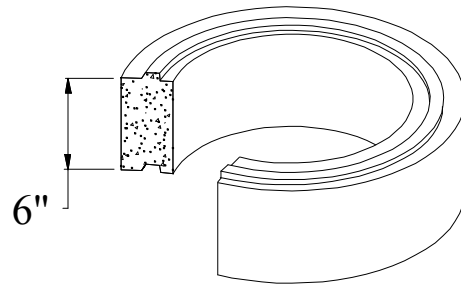

Wt = 212#

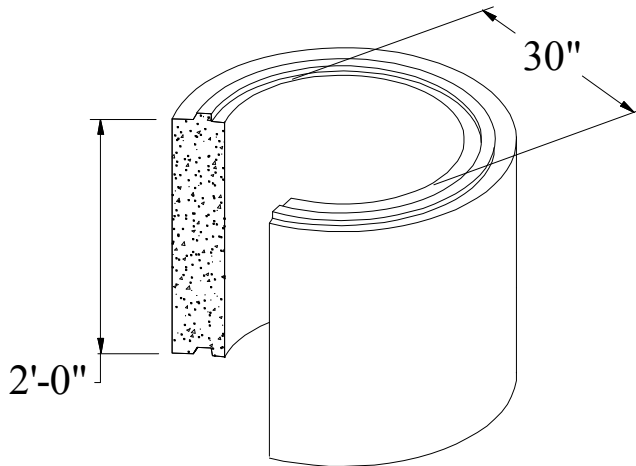

Wt = 848#

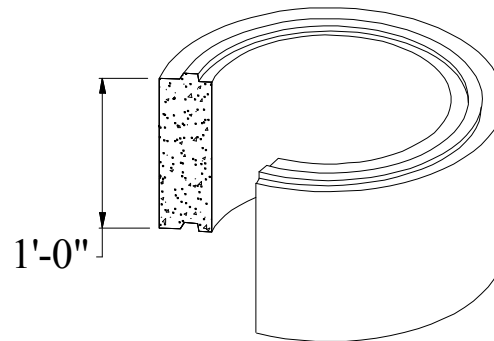

Wt = 424#

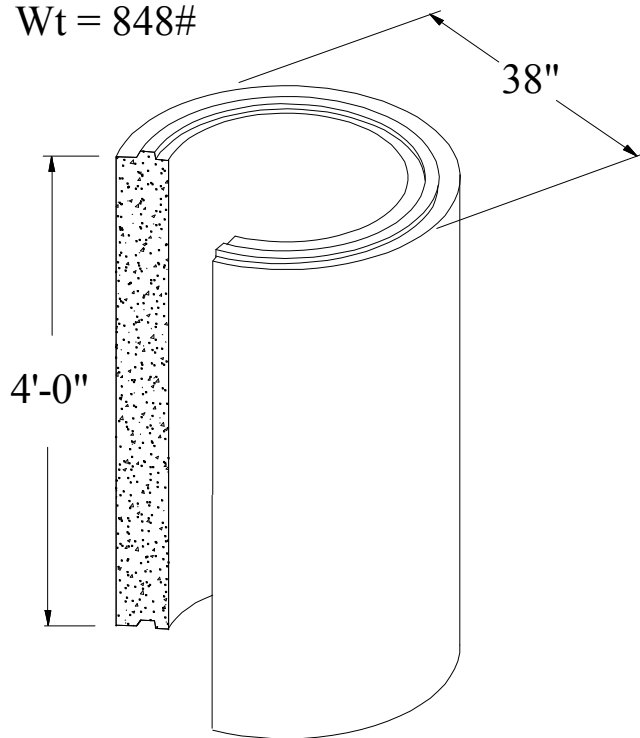

Wt = 1696#

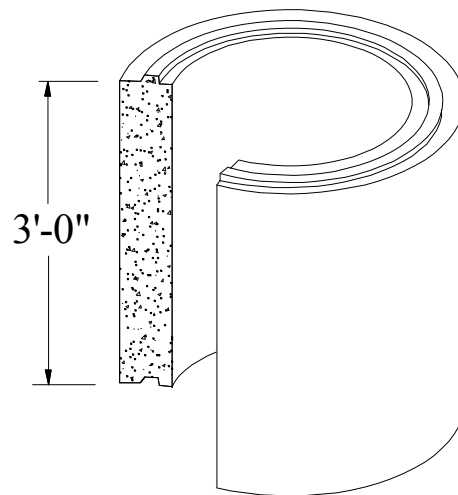

Wt = 1272#

- Knockouts Available in 2', 3' and 4' Risers
- Concrete Minimum Strength: 5,000 P.S.I @ 28 days
- Steel Reinforcement: AS-615-68, Grade 60
- Design Loading: AASHTO - H-20
- Meets ASTM Spec. C1227

**SHOREY PRECAST CONCRETE PRODUCTS**

351 Whites Path

S. Yarmouth, MA 02664

(800) 439-0965 • (508) 760-1070